

**Absorbtionsverlauf eines Plattenabsorbers**

- a) nicht hinterpolsterte Platte
- b) hinterpolsterte Platte

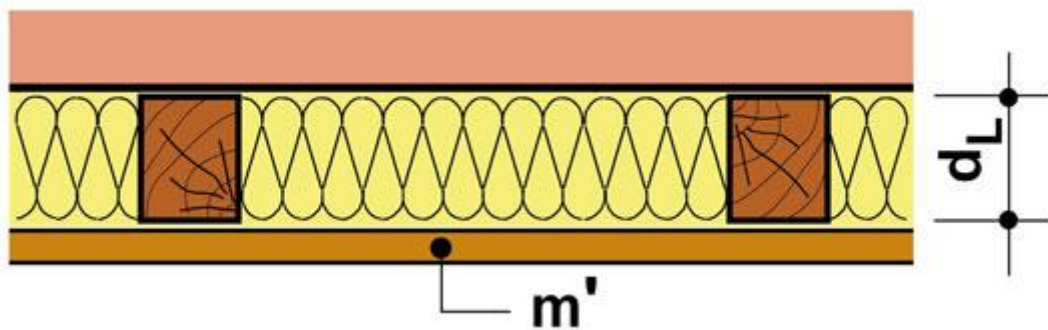

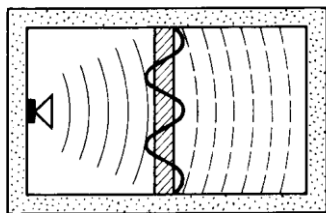
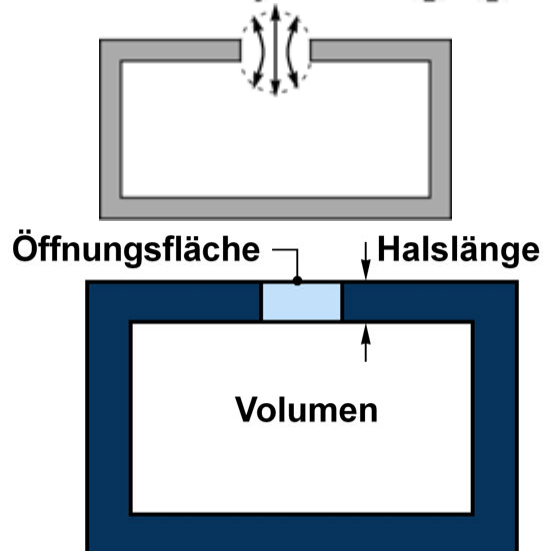
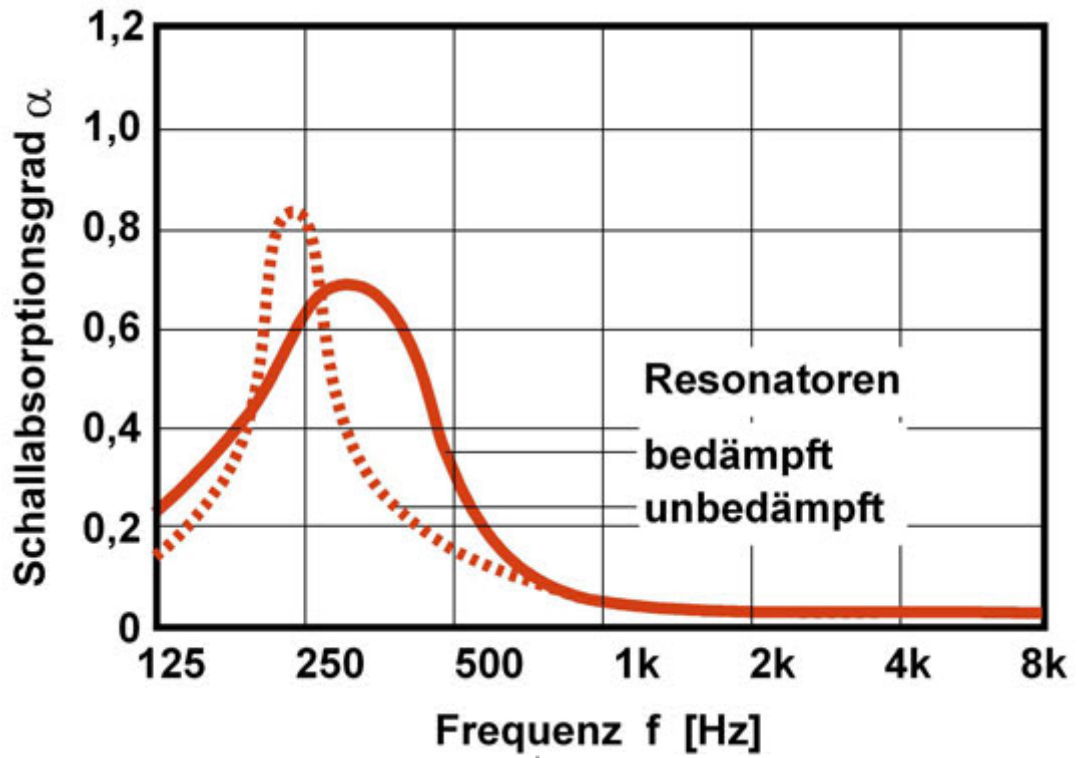

a)

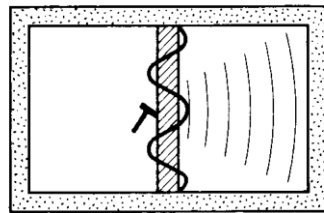

b)

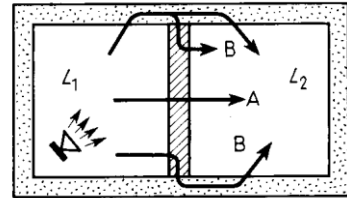

c)

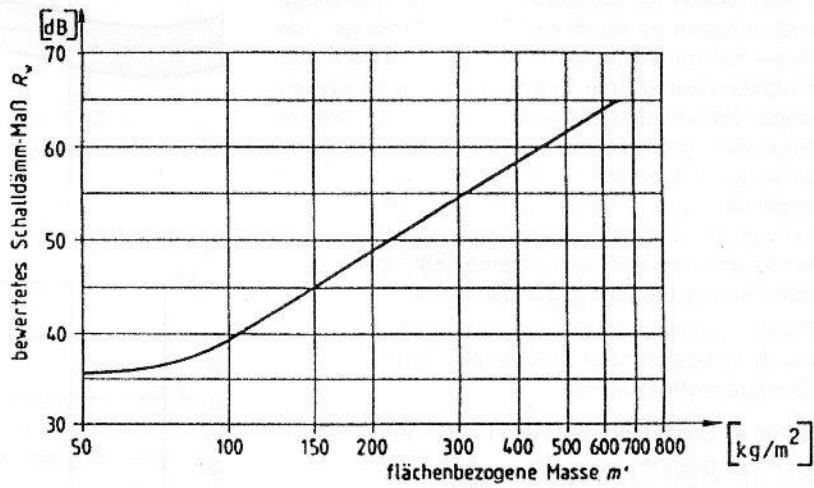
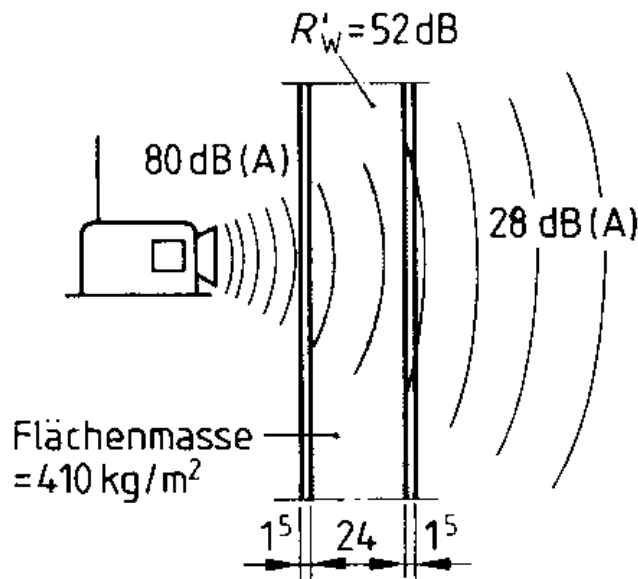
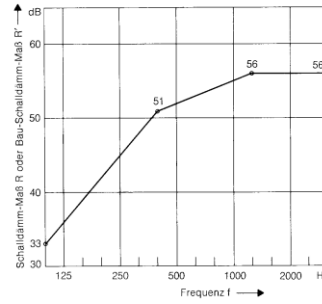
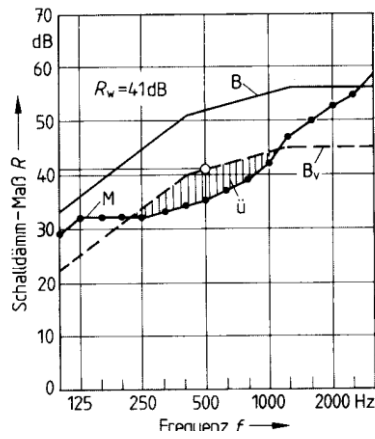

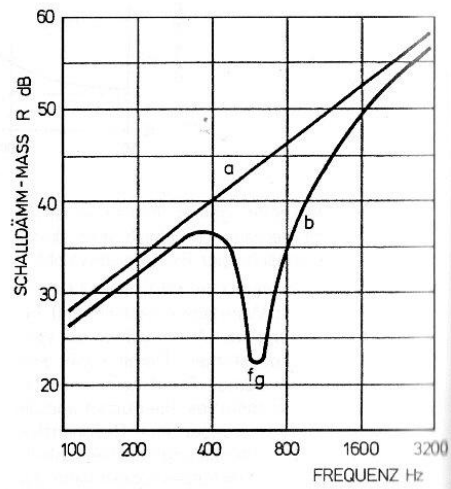
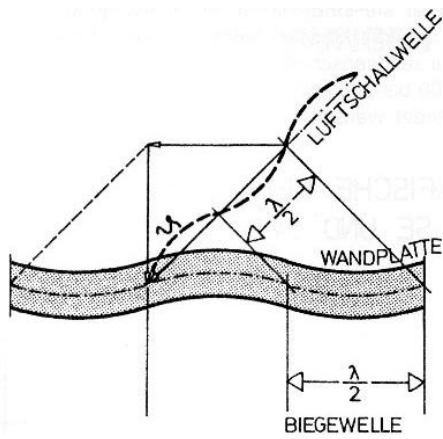
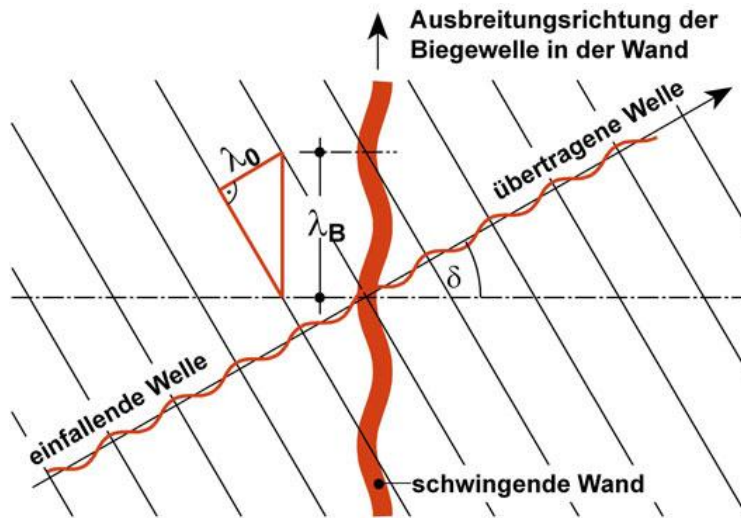

Putz  
Ziegelmauerwerk  
Luft  
Ständerwerk - Dämmstoff  
biegeweiche Vorsatzschale

